

VDI TOOL HOLDERS

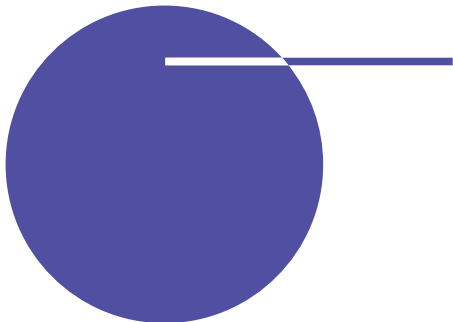
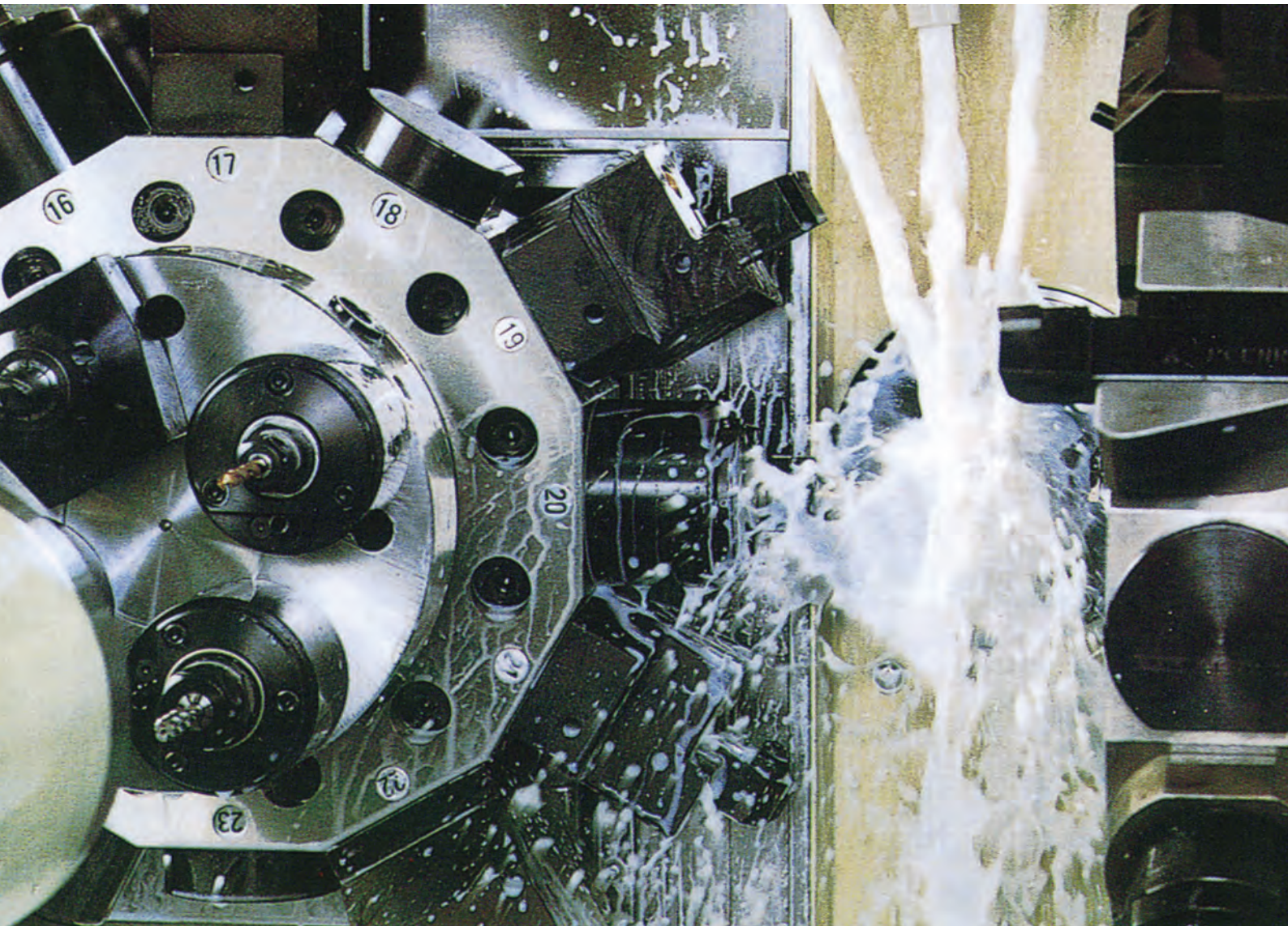
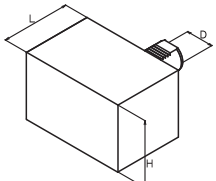
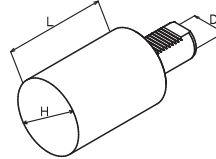
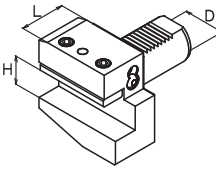
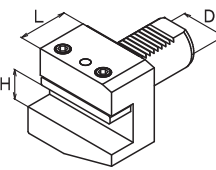
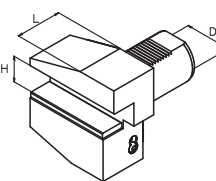
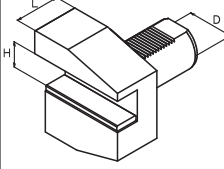
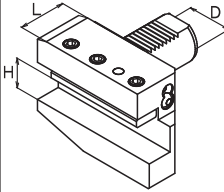
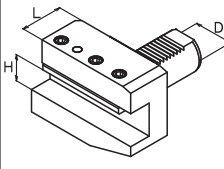
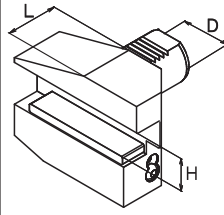
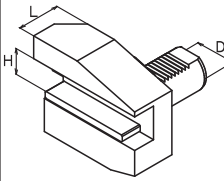

● **DIN69880準拠品** Compliant to DIN69880

Form	名称 Product name	シャンク径			ツール No Tool No
		D	H	L	
A1	長方形ブランク Rectangular tool holder 	20	60	65	A1200
		30	76	85	A1300
		40	96	100	A1400
		50	120	125	A1500
		60	125	160	A1600
		80	160	200	A1800
A2	丸形ブランク Round tool holder 	20	50	70	A2200
		30	68	100	A2301
				240	A2302
		40	83	120	A2401
				320	A2402
		50	98	135	A2501
60	123	150	A2601		
B1	バイトホルダB1形 Bite holder B1 type 	20	16	30	B1201
				40	B1202
		30	20	40	B1301
				60	B1302
		40	25	44	B1400
		50	32	55	B1500
		60	32	60	B1600
		80	40	75	B1800
B2	バイトホルダB2形 Bite holder B2 type 	20	16	30	B2201
				40	B2202
		30	20	40	B2301
				60	B2302
		40	25	44	B2400
		50	32	55	B2500
		60	32	60	B2600
		80	40	75	B2800
B3	バイトホルダB3形 Bite holder B3 type 	20	16	30	B3201
				40	B3202
		30	20	40	B3301
				60	B3302
		40	25	44	B3400
		50	32	55	B3500
60	32	60	B3600		
80	40	75	B3800		

Form	名称 Product name	シャンク径			ツール No Tool No
		D	H	L	
B4	バイトホルダB4形 Bite holder B4 type 	20	16	30	B4201
				40	B4202
		30	20	40	B4301
				60	B4302
		40	25	44	B4400
		50	32	55	B4500
60	32	60	B4600		
80	40	75	B4800		
B5	バイトホルダB5形 Bite holder B5 type 	20	16	30	B5201
				40	B5202
		30	20	40	B5301
				60	B5302
		40	25	44	B5400
		50	32	55	B5500
60	32	60	B5600		
80	40	75	B5800		
B6	バイトホルダB6形 Bite holder B6 type 	20	16	30	B6201
				40	B6202
		30	20	40	B6301
				60	B6302
		40	25	44	B6400
		50	32	55	B6500
		60	32	60	B6600
		80	40	75	B6800
B7	バイトホルダB7形 Bite holder B7 type 	20	16	30	B7201
				40	B7202
		30	20	40	B7301
				60	B7302
		40	25	44	B7400
		50	32	55	B7500
60	32	60	B7600		
80	40	75	B7800		
B8	バイトホルダB8形 Bite holder B8 type 	20	16	30	B8201
				40	B8202
		30	20	40	B8301
				60	B8302
		40	25	44	B8400
		50	32	55	B8500
		60	32	60	B8600
		80	40	75	B8800

Form	名称 Product name	シャンク径 D	H	L	ツール No Tool No
C1	バイトホルダC1形 Bite holder C1 type	20	16	55	C1201
				50	C1202
		30	20	70	C1300
		40	25	85	C1400
		50	32	100	C1500
		60	32	125	C1600
		80	40	160	C1800
C2	バイトホルダC2形 Bite holder C2 type	20	16	55	C2201
				50	C2202
		30	20	70	C2300
		40	25	85	C2400
		50	32	100	C2500
		60	32	125	C2600
		80	40	160	C2800
C3	バイトホルダC3形 Bite holder C3 type	20	16	55	C3201
				50	C3202
		30	20	70	C3300
		40	25	85	C3400
		50	32	100	C3500
		60	32	125	C3600
		80	40	160	C3800
C4	バイトホルダC4形 Bite holder C4 type	20	16	55	C4201
				50	C4202
		30	20	70	C4300
		40	25	85	C4400
		50	32	100	C4500
		60	32	125	C4600
		80	40	160	C4800
Z2	保護用プラグ Protective plug	20	50	16	Z2200
			30	68	16
		40	83	20	Z2400
		50	98	20	Z2500
		60	123	20	Z2600
		80	158	20	Z2800

Form	名称 Product name	シャンク径 D	穴径 d	ツール No Tool No
E1	サイドロックホルダ オイルホールドリル用 Side lock holder For Oil hole drill	20	20,25	E12-d
			30	20,25,32
		40	20,25,32,40	E14-d
		50	20,25,32,40,50	E15-d
		60	20,25,32,40,50	E16-d
		80	20,25,32,40,50	E18-d
		E2	サイドロックホルダ ボーリングバー用 Side lock holder For boring bar	20
30	8,10,12,16,20,25,32			
	40		12,16,20,25,32,40	E24-d
	50		16,20,25,32,40,50	E25-d
	60		16,20,25,32,40,50	E26-d
	80		20,25,32,40,50	E28-d
	E4		コレットホルダ Collet holder	20
30		16,20		
		40	16,20	E44-d
		50	16,20	E45-d
		60	16,20	E46-d
		80	16,20	E48-d
F1	モーリステーパホルダ Morse taper holder	20	MT1	F12-d
			30	MT1,2
		40	MT2,3,4	F14-d
		50	MT2,3,4	F15-d
		60	MT3,4,5	F16-d
		80	MT4,5	F18-d

備考：詳細寸法は別カタログをご請求ください。
Note: Please request a separate catalog for details.

本機仕様に合わせて製作致します。

We will manufacture it according to the machine specifications.



DIN 69880-1 シャンク部規格

Specification of shank part.

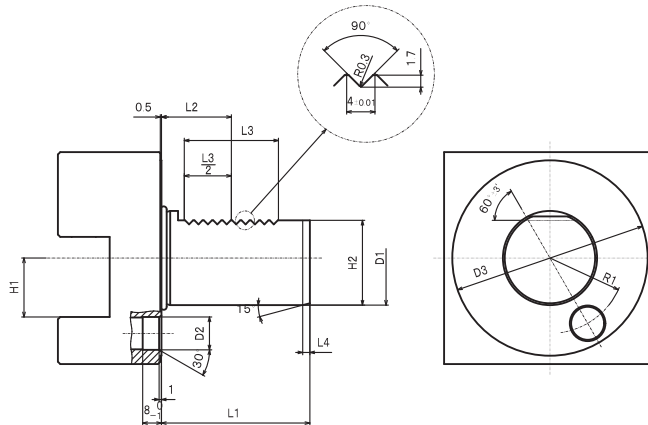

D1	L1	D2	D3	H1	H2	L2	L3	L4	R1
h6	±0.3			MAX.	±0.1	±0.05	MIN.	+1~0	±0.02
20	40	10 H6	50	16	18	21.7	24	2	18
30	55	14 H8	68	20	27	29.7	40	2	25
40	63	14 H8	83	25	36	29.7	40	3	32
50	78	16 H8	98	32	45	35.7	48	3	37
60	94	16 H8	123	32	55	43.7	56	4	48
80	124	18 H8	158	40	72	59.7	80	4	65

備考: Oリングは付属しませんので、使用の際は別途準備願います。 Remarks: O ring is not included, so prepare separately in case of use.



株式会社 **ALPS TOOL**

http://www.alpstool.com/ E-mail:alpstool@alpstool.com



ALPS TOOL

http://www.alpstool.com/ E-mail:alpstool@alpstool.com

本社・第一工場 / 〒389-0601 長野県埴科郡坂城町大字坂城10070 ☎(0268)82-2511 機 FAX(0268)82-7368
 第二工場 / 〒389-0601 長野県埴科郡坂城町大字坂城10030 ☎(0268)82-4811 機 FAX(0268)82-8741
 第三工場 / 〒389-0602 長野県埴科郡坂城町大字中之条102-8 ☎(0268)82-7911 機 FAX(0268)82-7919
 東京営業所 / 〒181-0013 東京都三鷹市下連雀9-11-2 ☎(0422)46-2981 機 FAX(0422)47-9641
 北関東営業所 / 〒374-0024 群馬県館林市本町2-12-23坂本ビル ☎(0276)75-3441 機 FAX(0276)75-3544
 名古屋営業所 / 〒485-0016 愛知県小牧市閻々原新田652-4 ☎(0568)73-0246 機 FAX(0568)73-1328
 大阪営業所 / 〒581-0811 大阪府八尾市新家町3-21-1 ☎(072)943-4601 機 FAX(072)943-4602
 広島営業所 / 〒739-0024 広島市西条町大字御園宇8568-2 ☎(0824)22-9271 機 FAX(0824)22-9274
 信越営業所 / 〒389-0602 長野県埴科郡坂城町大字坂城10070 ☎(0268)82-2511 機 FAX(0268)82-7368
 東北営業所 / 〒989-0246 宮城県白石市南町2-1-45 ☎(0224)25-7661 機 FAX(0224)25-7704

HEAD OFFICE / 10070 Sakaki, Sakaki-machi, Hanishina-gun, Nagano-ken, Japan.
 Postal code No, 389-0601
 PHONE:0268-82-2511 FAX:0268-82-7368

